

SIP-1013

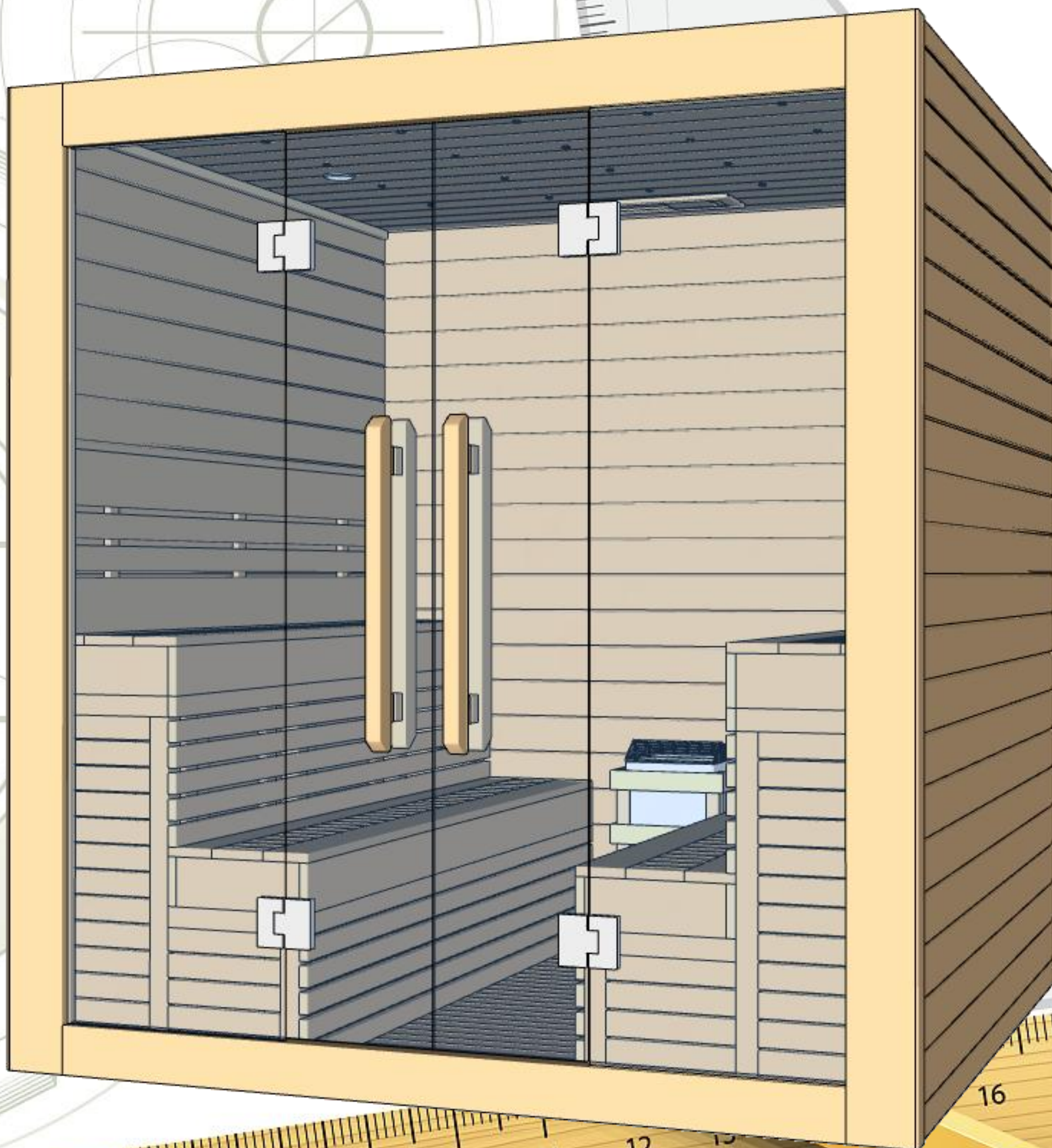

Instructions are for reference only.

HidroTerm
grejanje & bazeni

TermoPool
grejanje & bazeni

1.Introduction

We welcome you to the most affordable sauna in the country! We also congratulate you on embarking on a new path towards better health! Thousands of users enjoy the benefits of sauna every day. Sauna can help burn calories, reduce toxins, relieve pain, and even clear complex symptoms. Now, you can enjoy the huge benefits of high temperatures within the price range of your own home.

We are committed to providing high-quality home health products at affordable prices. Our customer list is growing every day, and we believe that your success is our success. Our employees have over 15 years of professional experience and are always ready to provide you with high-quality customer service.

2.Highlights

- a.High quality craftsmanship
- bAutomatic thermostat for constant temperature
- c.Timer and buzzer:buzzer sounds 5 minutes before the end of session
- d.Digital sensor and thermometer
- e.Sauna stove

3.Installation

1.Installation requirements

- a.Do not plug any other appliances into the outlet with your our sauna.
- b.Install the sauna on a completely level floor.
- c.Do not spray the exterior with water.If the floor is damp,install a floor separator to keep the sauna high & dry.
- d.Do not store flammable objects or chemical substances near the sauna.

4. Installation Procedure

Step 1: Raise the rear wall panel and stand it on a flat and dry ground.

Step 2: Erect the left wall panel and secure it to the rear wall panel using stainless steel screws. Fix the right wall panel using the same method.



Figure 1

Step 3: Fix the seat bracket to the left and right walls.

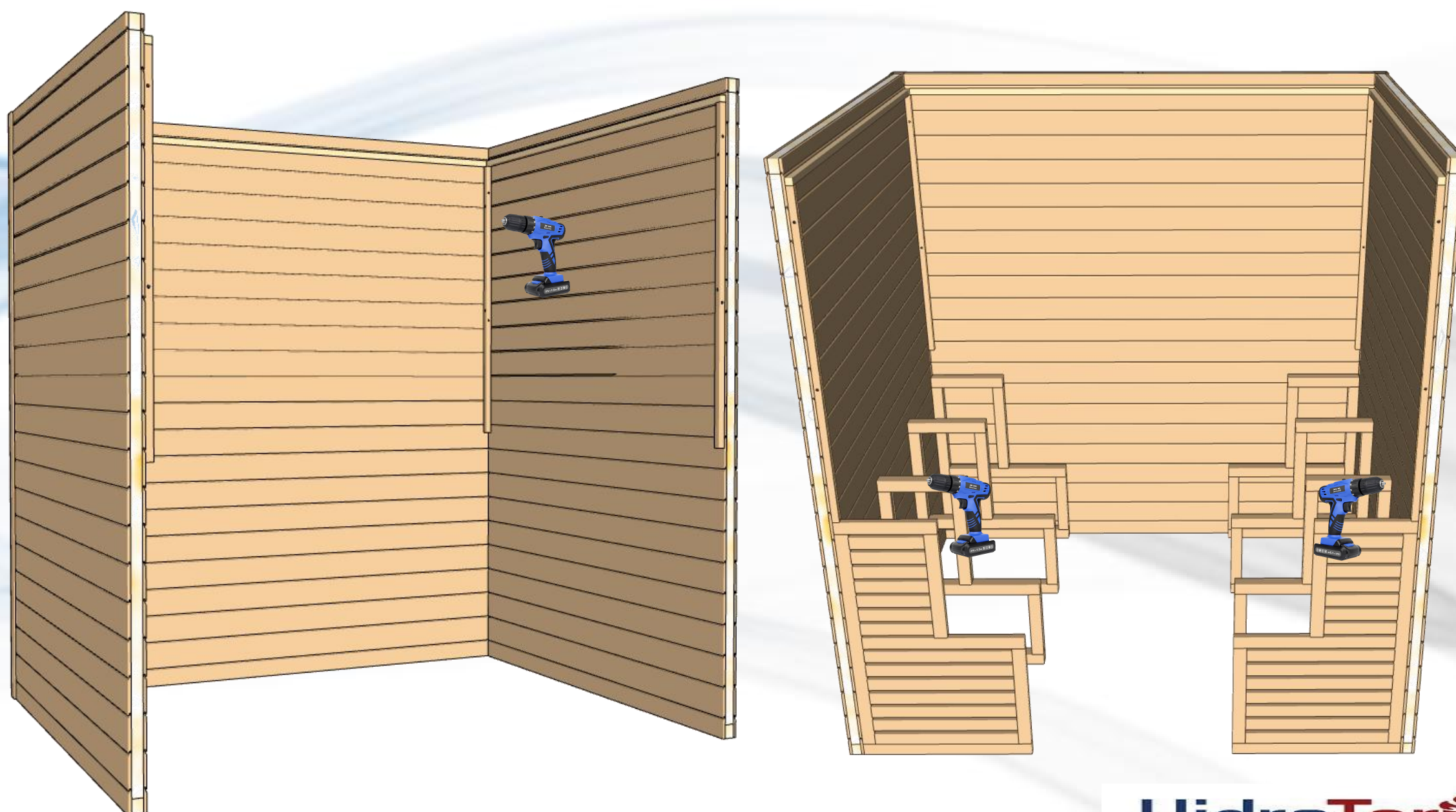

Figure 2

4. Installation Procedure

Step 4: Place the floor in a suitable location.

Step 5: Place the seat plate guard and seat plate, first place the lower guard plate and lower seat plate according to the size, then place the upper guard plate and upper seat plate, and fix them with screws.

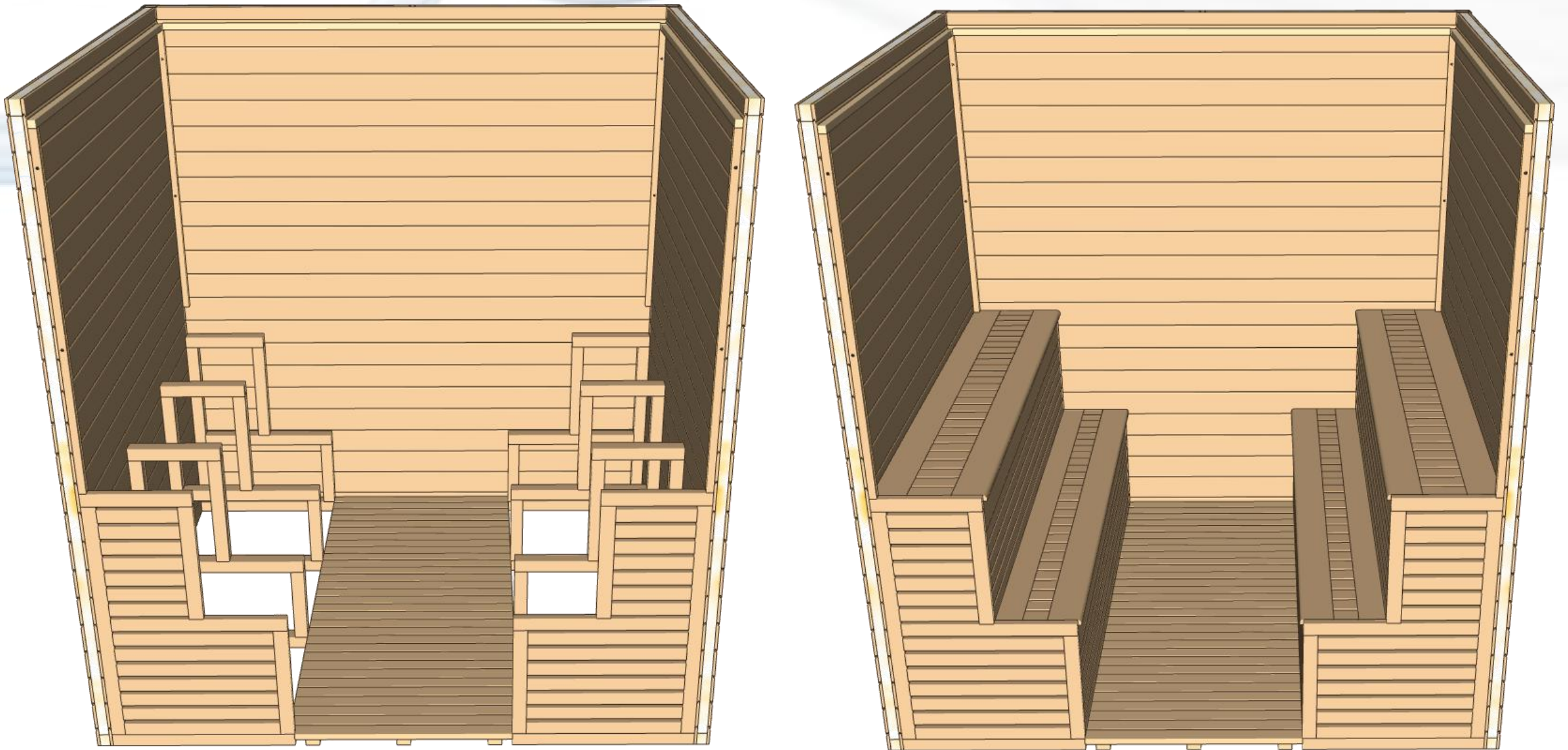

Figure 3

Step 6: Installation of backrest version: Based on personal preferences and backrest habits, determine the fixed position only for the back, and do not fix the position when leaving the factory.

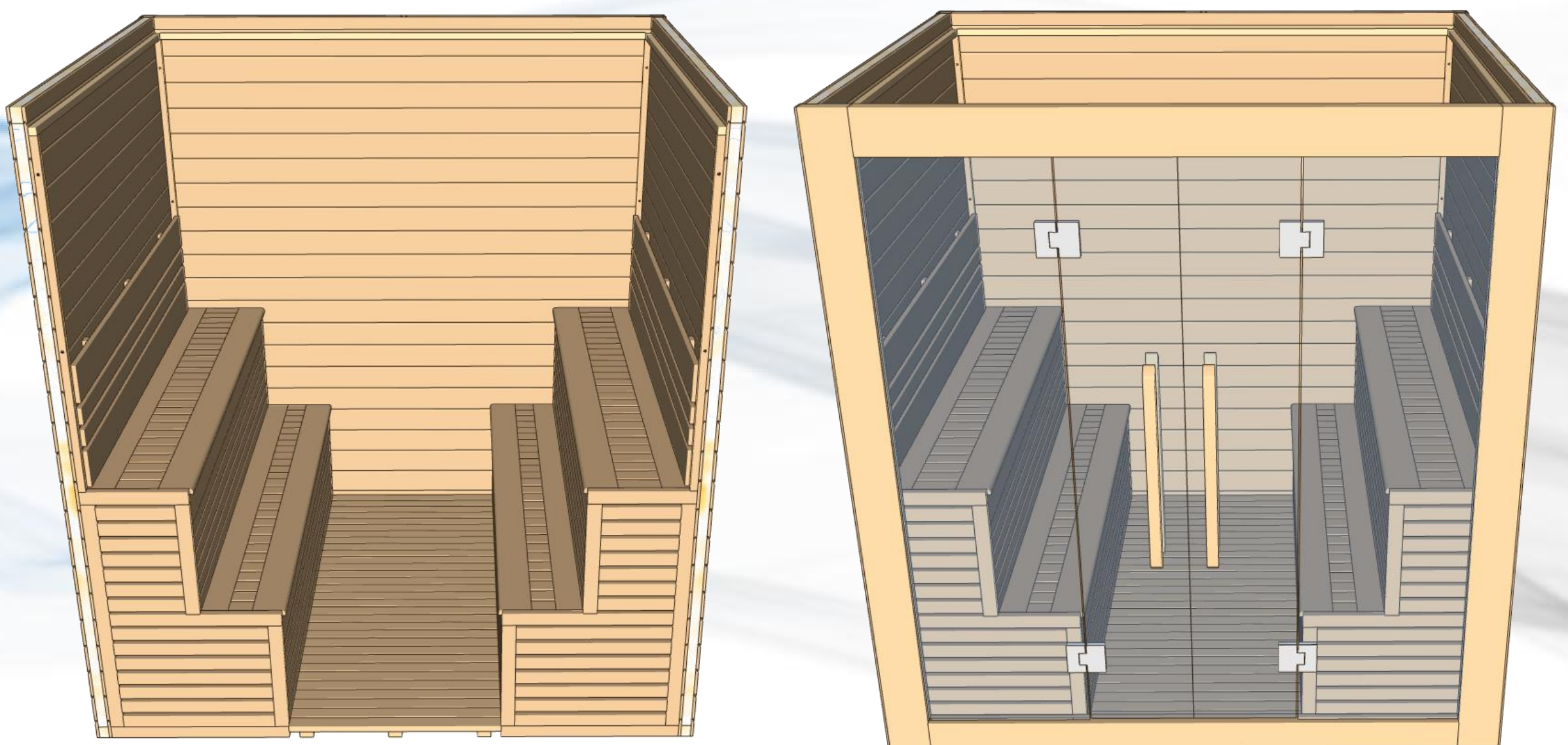

Figure 4

4. Installation Procedure

Step 7: Installation of front wall panel: The glass is heavy and requires at least 2 people to stand upright and hold it firmly against the left and right wall panels, and fix it internally with screws.

Step 8: Lift the top plate, place it at the top of the middle of the wall, and clamp it tightly with the four walls.

Step 9: Install the sauna stove, connect the corresponding connectors, and test the power. Installation completed.

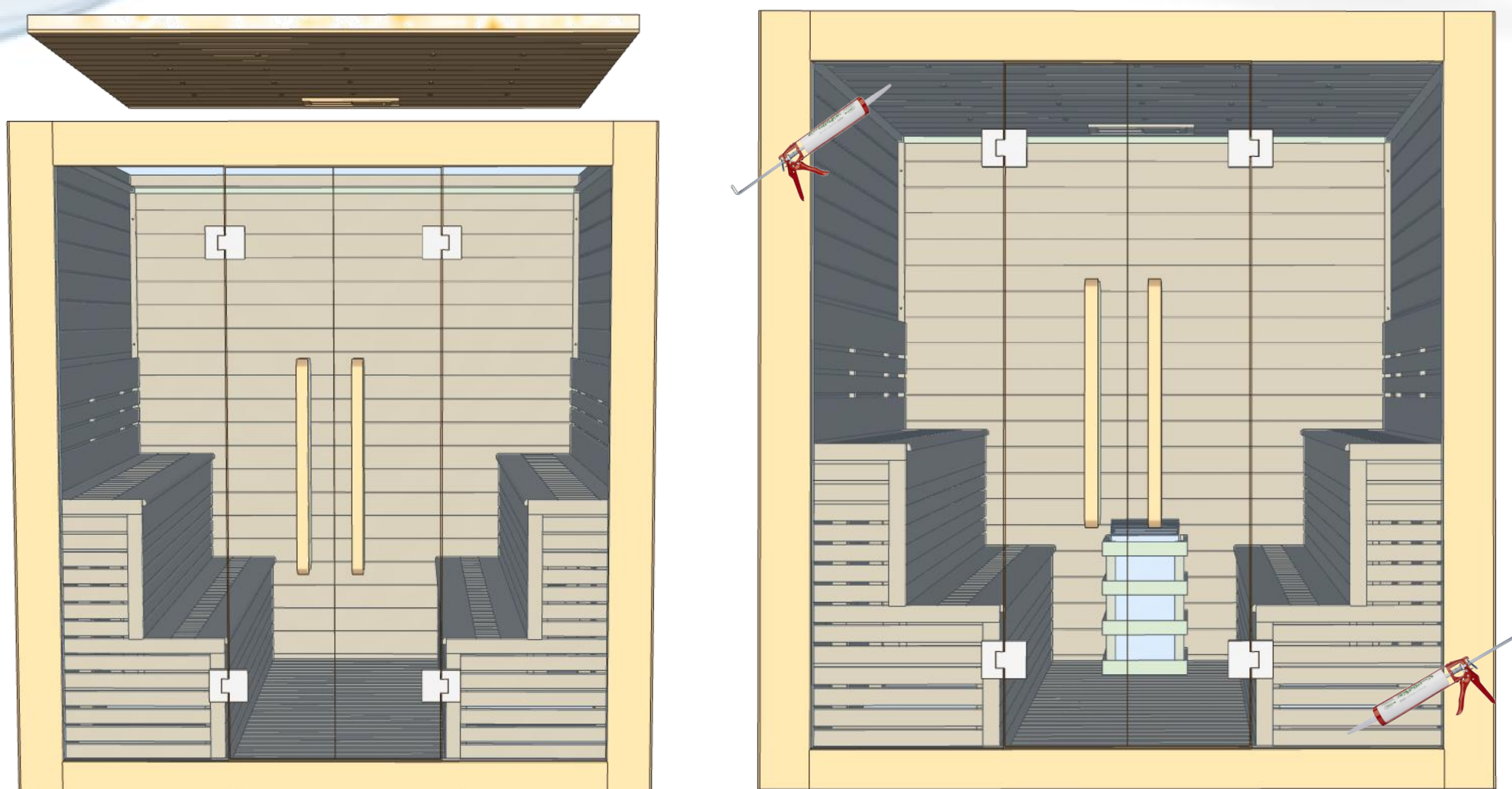

Figure 5

Step 10: Overall analysis.

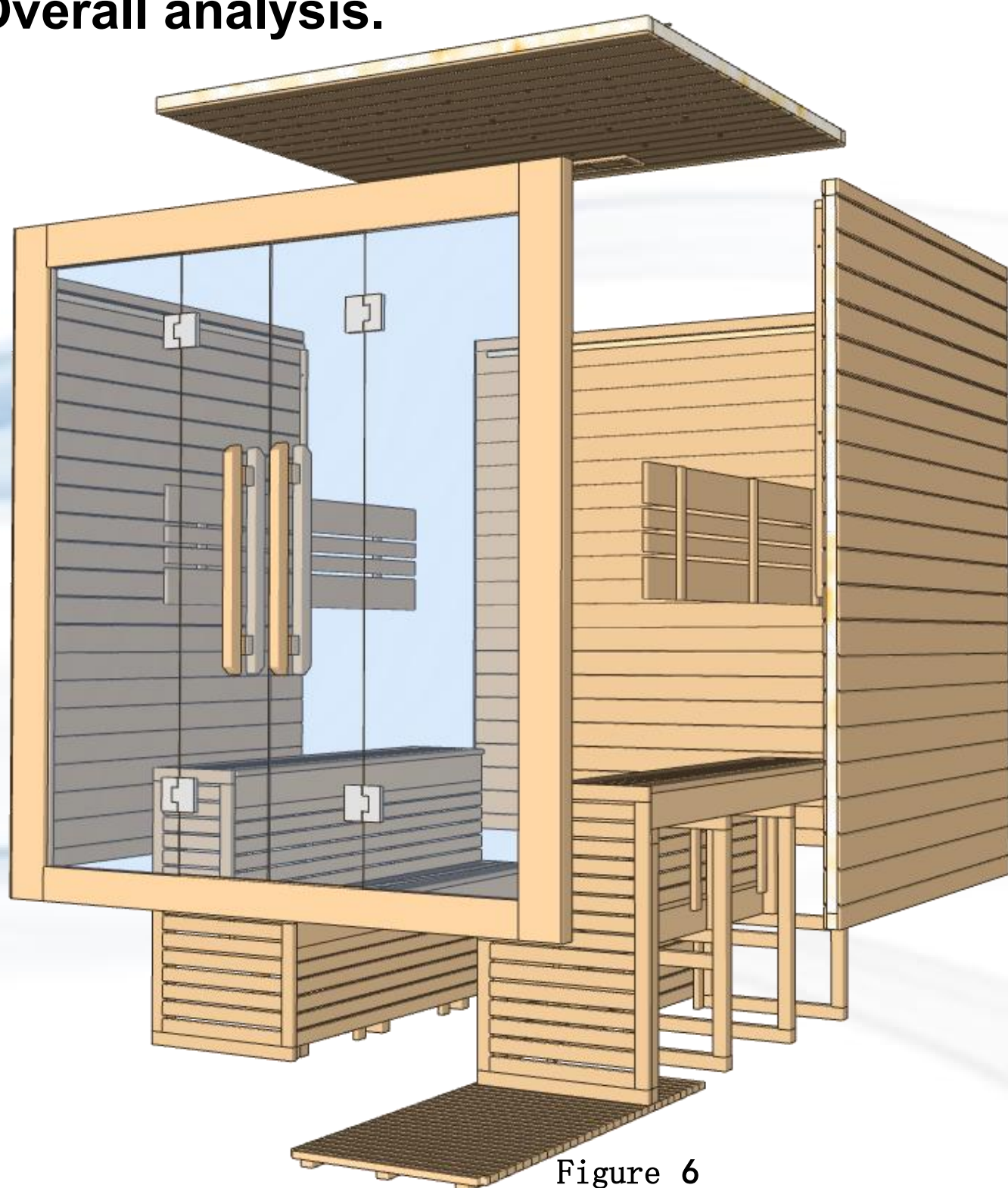

Figure 6

Connect all the wires of the stove. **SEE A: havira stove B: Ordinary sauna stove**

A: havira stove

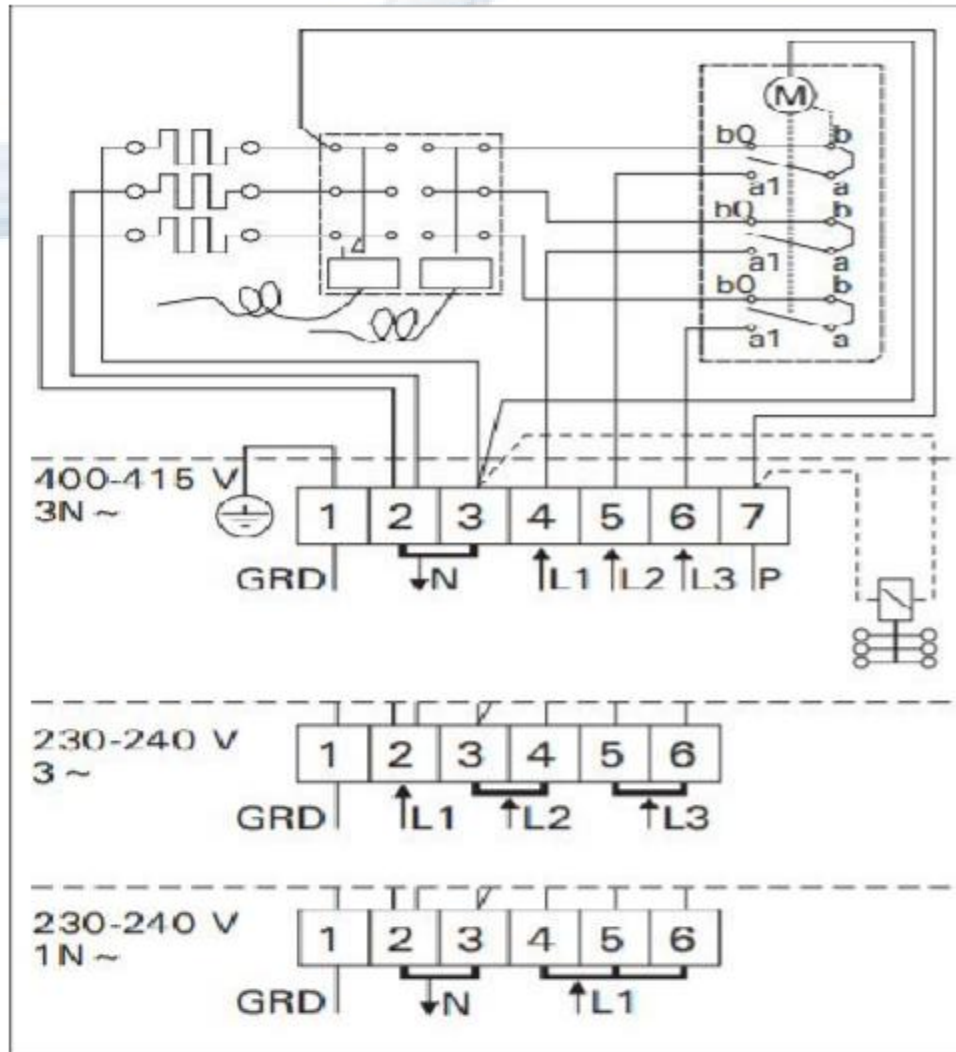

Figure 10. Raccordements électriques du poêle (BC)
Figuur 10. Elektrische aansluitingen (BC)

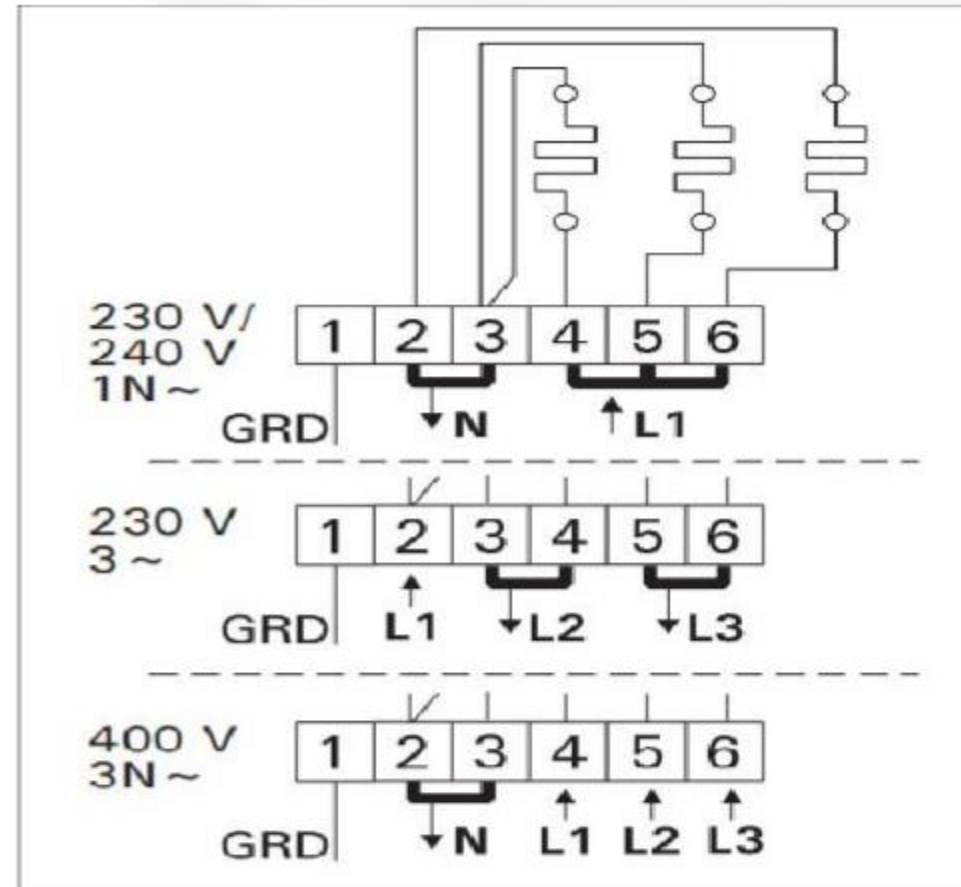

Figure 11. Raccordements électriques du poêle (BC-E)
Figuur 11. Elektrische aansluitingen (BC-E)

B: Ordinary sauna stove

354SkSM 110A		Heating Elements 230V/240V				
Power KW		SEPC 62 1000W	SEPC 63 1500W	SEPC 64 2000W	SEPC 65 2670W	SEPC 63B 3000W
3.0		1, 2, 3				
4.5			1, 2, 3			
6.0				1, 2, 3		
8.0					1, 2, 3	
9.0					1	2, 3

Figure 7

380V 3N~/415V 3N~
220V 1N~/240V 1N~ 4.5K/6.0mm²/3.0 2.5mm²

- (1) L L1 L2 L3—Connection ports of live wire
- (2) N-----Connection port of neuter wire
- (3) ⊕-----Connection port of grounding wire

1.0 Far infrared sauna or traditional sauna precautions

- a. Check that all circuits, plugs or circuit breakers meet the requirements. (Customers need to configure their own cable connections according to the local voltage.)
- b. Set the temperature and time to a comfortable level, usually 120°F for 30 minutes
Drink a glass of water before the sauna.
- c. After 2 hours of continuous use, close the sauna for 1 hour.
- d. Do not touch the heating element to avoid burns.

2.0 Operation

- a. All electrical and electrical control related electrical work in the sauna must be operated and installed by professionals holding electrical certificates.
- b. The sauna has two temperature control methods: the external control system (using the independent manual) or the temperature control switch on the sauna stove to operate (using the independent manual).
- c. Press the Light key to turn on or off the indoor light.
- d. If the sauna is too stuffy, open the ceiling vents or open the front door.
- e. After the sauna, turn off the power or disconnect the circuit breaker.

Warnings

1. Safety precautions

- a. To avoid fire, do not dry clothes or leave any towels in the sauna.
- b. To prevent burns or electric shocks, do not touch or use metal tools on the net cover of sauna stove
- c. While in the sauna, do not touch the lightbulb. If the bulb needs to be changed, switch it off and wait until the sauna is shut off and the bulb is cool.
- d. Do not use the sauna if you have any of the following conditions;
 1. Open wounds
 2. Eye diseases
 3. Sever diseases
 4. Elderly & weak people, especially those suffering from a disease, pregnant women and infants are prohibited. Children over the age of 6 years may use the sauna under the supervision of adults.
 5. If suffering from a disease directly related to temperature, seek the advice of a doctor before using.
 6. Do not place pets in the sauna.
 7. Do not use the sauna if you are under the effects of alcohol.

Trouble Shooting:

	Problem	Possible Causes	What To Do
1	Indicator light for power supply not working	The connector is not connected properly	Check the connector or replace a new one
		The fuse is burned	Change the fuse
2	Indicator light for function is not working	The corresponding indicator light is broken	Replace the relevant control panel
		The circuit board or components are broken	Replace the circuit board
3	Stove not heating up	Stove is broken & infrared heater	Replace with a new one of the same specifications
		Its life will be shorted gradually for being used for many times	
		The fuse is burned out: L-Hand fuse holder: For back panel R-Hand fuse holder: For front panel	Replace with a new one of the same specifications

3	Stove not heating up	The wire junction is loose or the heater's wire is loose	Check it, and reconnect them tightly
		The circuit board relay is not functioning	Replace circuit board
4	Malfunctioning of Temperature setting	Some problems with heater	See the 3rd section of heater problem
		Senor wire is not functioning	Re-connect or replace the senor wire
		The circuit board for temperature controlling is not function	Replace the control panel circuit boare
5	Odor from the sauna	The circuit problems (fuse holder wire is loose, junction wire is loose, circuit board components is broken)	1)disconnect the power, check the power supply and voltage; 2)Find the objects with problems 3)Replace the damage
6	Light bulb is not working	Light bulb is burned out	Replace the light bulb
		Light bulb wiring is loose	Check connector or reconnect theLight bulb wiring
		The light bulb connector is broken	Replace it
		Problems with electrical control panel	Repair or replace it

Maintenance

Cleaning

Clean the faceplate with a wet towel, or clean with a small amount of hand-doap mixed with warm water if necessary. Clean the sauna room with a wet cotton towel, dry with a clean dry towel. **Do no use benzene, alcohol, or strong cleaning chemicals on sauna, NOTE: Any chemical that can damage wood material will damage the sauna and the protection layer that is on the wood.**

Do not leave the sauna on for more than 2 hours at a time, Transportation and storage

1. Avoid exposure to rain, snow or strong collisions during transport.

2. Do not store in damp environments.

Packing List (Traditional sauna room)

1x sauna room with floor 1xSauna barrel 1xDoor handle
 1x Backrest 1xSand glass 1xscrew
 1x Instruction manual 1xSauna spoon 1x Themo hygrometer

Packing List (Infrared sauna room)

1x infrared sauna room 6 faces 1x stool 1x door handle
 1x screw kit 1x touch control system

Warm tips:

The above instructions belong to the far infrared sauna room and the traditional sauna furnace sauna room is a general comprehensive manual, customers according to their own purchase of the style to debug and install. Infrared sauna room also has a control system operating instructions, please consult separately.

Precautions for use Tips :

Generally, customized products are divided into four categories: 1. (Sauna room) adopts sauna stove heating principle; 2. (Spectrum room) adopts carbon crystal heating plate heating principle; 3. (Light wave room) adopts ceramic heating tube heating principle; 4. (Steam room) adopts electric heating film heating principle.

The following describes the use of various houses and matters needing attention in installation:

1. sauna room:

- a. The sauna room needs to be watered frequently when using the stove to avoid wood deformation and cracking caused by excessive indoor drying.
- b. The sauna room temperature is high. Please set the adaptive temperature when using the sauna room temperature to avoid discomfort.

2. spectrum room, light wave room, steaming room:

- a. The main heating materials of the spectrum room, light wave room and steaming room are (carbon fiber heating plate, ceramic heating tube and low-temperature radiant electrothermal film).
- b. If it takes more than 90 minutes and reaches 90 minutes, it should be suspended for about 50 minutes before being used again. In case of hot weather, it should be suspended for about 3 hours before being used again. Never water or sprinkle water on the steaming room, spectrum room, light wave room or heat source, or touch the heat source with wet substances (the heat source is made of waterproof material).
- c. Please don't clean the house with water or wet things when cleaning it.
- d. Do not use organic solvents for decontamination, such as gasoline and alcohol. ...
- e. It is generally appropriate to use the house for about 30-45 minutes each time. (Power must be turned off after use)
- f. Every day or after each use, finally continue to heat for about 5 minutes, at the same time, open the door of the room or vent to discharge the moisture in the room, keep the room dry.
- g. Dry, when not used for a long time across the month, it should be heated for about 40 minutes in about 20 days. (The power supply must be cut off after use)
- h. When using the room, you must take two (dry) towels or bath towels, one on your knees to absorb sweat.

3. the use of precautions:

- a. The proper temperature of the house must be set according to the individual's bearing capacity.
- b. Individuals must turn off the power in time after use.
- c. Never touch the heating part and control panel with metal or hard objects.
- d. Never let the house work at high temperature for a long time.
- e. Do not sleep in the room when the room equipment is working.
- f. Children should be accompanied by adults.
- g. Do not touch the heating source (heating tube, heating plate, heating film and other materials with heating function) with your hands, sticks and other objects.
- h. Do not use or store hair gel, gasoline or oil near or in the equipment.
- i. Paint and other flammable gases or liquids to avoid fire.
- j. Please don't eat within 1 hour before using the house, so as not to feel uncomfortable.
- k. You should drink proper water before using the house.
- l. Warning: The following patients are prohibited: those with bleeding tendency, patients with severe hypertension, heart disease, tuberculosis, acute diseases, patients with high fever and malignant diseases.
- m. Cancer patients, patients with infectious skin diseases, pregnant women and parturients.

4. the installation matters needing attention:

- a. The power of the steam, light wave and spectrum room is within 3kw, and the control box is equipped with a leakage protection switch. The installation place of the power cord plug of the equipment should be placed above.
- b. The location of the house body, do not use plug-in transfer, so as to avoid danger.
- c. The electric boxes of the specially customized high-power steaming room, light wave room and spectrum room are all equipped with cables of about 1-1.5 meters (no leakage protection switch). Please contact the dealer to find a professional electrician to install the electric function, and properly install the wiring on site.
- d. Install the leakage protection switch by yourself, and the leakage switch must be installed in the high-power room, and the electricity must not be installed without authorization.
- e. The main power supply wiring is not included in the sauna room. Please find a professional electrician to install the cable and leakage protection switch according to the site.
- f. When the test is finished, you must observe it, and you must not leave the site after starting it. After ensuring the normal work, you can leave the site after closing the function of the house correctly.

Outdoor sauna room:

Purchase Notice: Please carefully read the installation prerequisites: Customers must have sockets, cables, or circuit breakers with reasonable product power and voltage before purchasing

Factory standard configuration: Infrared light wave room voltage V220, power below 3kw, standard 15-16A plug (medium plug/European plug/English plug/Australian plug/South African plug)

(American plug/Japanese plug) Special limited to cables within 1.5kw and exceeding 1.5kw can only be connected

All plugs that require customization for 110V and over 1.5kw can only be connected to cable wires

All customized 110V voltages cannot exceed 3kw. Only customized voltages above 220V are allowed

Over 3kw-9kw with standard 2-meter-long national standard cable 220V 4 square/6 square or national standard 6 square 380V

Customization of high-power infrared light wave rooms requires communication on wiring and electrical box customization before placing an order

Traditional sauna rooms do not require wiring, and customers need to hire professional electricians to determine the appropriate power line and voltage to match the purchased product with amperes based on their on-site environment.

Installation tools: Requires a screwdriver, electric drill, glass glue, glass glue gun, level, sandpaper, hole opener, hammer, and other series of tools

1. The customized product images are for reference only and may have certain differences and color differences from the actual product. The basic configuration is based on the factory standard configuration, and the images are for reference only. They belong to woodworking customized products, so each factory's production has detailed differences and does not belong to any quality issues

2. Outdoor sauna room: If customers choose all styles of wooden doors, they need to emphasize to them that wooden doors are prone to deformation (customers need to be mentally prepared for long-term maintenance of wooden doors), which is not a product quality issue

Outdoor wood depreciation discoloration:

3. Outdoor acrylic arch ball (hottest spot, high temperature resistance not exceeding 70 degrees).

4. Indoor: There is no door tape in the middle of all glass to glass styles (if the customer needs door tape, prepare for long-term replacement, this is a consumable)

5. Sauna room usage level, time frequency, and other vulnerable accessories: hinges, hinge pads, hinge screws, door handles, handles, plastic parts, stones, lighting fixtures

6. Damage caused by human operations such as transportation and handling is not a quality issue.

7. The sauna room is made of pure solid wood material: there may be a few machine cuts, extremely broken edges, nail and screw marks, and other assembly and disassembly on the wood (all normal). Some styles of products that require trial installation will have traces of trial installation.

8. All types of wood: Over time, there will be depreciation, color oxidation, and outdoor use will be more severe. None of them belong to quality issues.

9. The customer needs to know all the terms and conditions of the shipping plan and accept them after negotiation. The default shipping cost method in the contract is based on the official default.

10. The sauna room is made of pure solid wood material: there may be a few machine cuts, extremely broken edges, nail and screw marks, and other assembly and disassembly on the wood (all normal).

11. The customer needs to know all the terms and conditions of the shipping plan and accept them after negotiation. The default shipping cost method in the contract is based on the official default.

12. Our manufacturer only provides free CE certificates, UKCA certificates, and FCC certificates for sauna rooms and infrared light wave rooms. If other certificates are required based on product styles and requirements of various countries and regions, the purchaser needs to provide financial assistance to handle them. If there are many certificate requirements in the local area, please purchase with caution and investigate the sales standards.

Indoor sauna room:

1. The customized product images are for reference only and may have certain differences and color differences from the actual product. The basic configuration is based on the factory standard configuration, and the images are for reference only. They belong to woodworking customized products, so each factory's production has differences in details and does not belong to any quality issues.

2. Indoor: There is no door tape in the middle of all glass to glass styles (if the customer needs door tape, prepare for long-term replacement, this is a consumable)

3. Sauna room usage level, time frequency, and other vulnerable accessories: hinges, door handles, handles, plastic parts, stones, lighting fixtures

4. Damage caused by human operations such as transportation and handling is not a quality issue.

5. The sauna room is made of pure solid wood material: there may be a few machine cuts, extremely broken edges, nail and screw marks, and other assembly and disassembly on the wood (all normal).

6. All types of wood: Over time, there will be depreciation, color oxidation, and outdoor use will be more severe. None of them belong to quality issues.

7. The customer needs to know all the terms and conditions of the shipping plan and accept them after negotiation. The default shipping cost method in the contract is based on the official default.

Warranty options:

1. Purchase all brands: All sauna stoves (stove tubes are consumables and are not covered by warranty)

(Domestic sauna stoves have low prices and no warranty) It is recommended that customers buy a spare or a new stove if it breaks down.

(Harvey's home sauna stove comes with an 8-month warranty. If there is a malfunction, customers need to provide photo codes and evaluate the faulty parts. The factory will apply for free parts, excluding shipping and service fees.)

If the customer violates the rules by using the indoor style control system outdoors, there is no warranty for the use of Havea. Due to the high frequency of use in public places, there is no warranty for commercial use. The warranty terms are only for household use.

Sauna room usage level, time frequency, and other vulnerable accessories: hinges, door handles, handles, plastic parts, stones, lighting fixtures

2. Domestic control system (for home use, if the malfunction is caused by non-human factors, it can be guaranteed for 1 year. During this period, if the control system has non-human factors, provide pictures and photos, evaluate the damaged parts, and a new set of confirmed faulty controller boxes or panels can be sent free of charge, excluding shipping and service fees)

Due to the high frequency of use in public places, there is no warranty for commercial use. The warranty terms are only for household use.

3. You can also purchase warranty time and extend the warranty.

Reminder: All products need to be assembled by certified electricians and installers. All cables and circuit breakers outside the installation room require professional guidance from electricians (not included as accessories in the product)

Tips

1. It is recommended that customers regularly undergo anti-corrosion treatment for solid wood outdoor saunas to ensure the longevity of the wood. (Customers need to take care of themselves. It is recommended to use locally available transparent anti-corrosion oils such as wood wax oil, which customers can choose for themselves.)
2. Far infrared rooms and saunas are natural wooden products that should be avoided from being soaked in water or getting damp. They should be used on damp floors
An isolation layer should be added to the ground, such as placing it in a shower room in the bathroom to ensure that the product is not corroded by damp environments. Avoid sunlight
Direct sunlight and strong storm winds can cause one side to dry, crack, and age.
2. The power cord plug of the device should be placed in a location that is not accessible and should not be plugged in to avoid danger
Insurance, the manufacturer does not cover the installation of the main power wiring. Please contact the dealer to find a professional electrician to install the electrical function
The power room must be equipped with a leakage switch for electrical installation, and unauthorized installation is strictly prohibited.
3. Before use, a professional should correctly install the power supply, conduct testing and inspection, observe from the side, and do not test during the testing period
After leaving the site to ensure the safety and normal operation of the building, the functions of the building must be properly closed before leaving the site.
4. The main heating materials for far-infrared rooms are heating plates, ceramic heating tubes, and electric heating
The continuous operation of the membrane heating element should not exceed 1.5 hours. If it reaches 1.5 hours, it should be paused for about 50 minutes before being used again
During hot weather, it should be paused for about an hour before being used again. Please note that if there is a temperature detection control system, pay attention to timing
Check if the controller is functioning properly, and if there are any issues, please conduct timely testing and maintenance.
5. It is generally recommended to use the room for about 30-80 minutes each time. (After use, the power must be turned off)
6. After each day or use, continue heating for about 5 minutes, while opening the door or vent of the room to discharge it
The moisture inside should be kept dry. When not in use for a long time, it should be heated for about 40 minutes for about 20 days. (Using)
The power must be cut off after completion
7. The appropriate temperature of the room must be set according to individual tolerance
8. After personal use, the power must be turned off promptly.
9. Do not touch the heating parts and control panel with metal or hard objects.
10. Do not let the house work in high temperatures for a long time
11. Do not sleep inside the room while the equipment is working.
12. Children should be accompanied by an adult when using it
13. Do not water or sprinkle water inside the room or on the heat source, or touch the heat source with wet substances (all heat sources are made of non waterproof materials)
Do not clean the room with water or wet objects during cleaning
14. Do not use organic solvents such as gasoline, alcohol, etc. to clean up
15. Do not touch the heating source (materials with heating functions such as heating tubes, heating plates, heating films, etc.) with your hands, sticks, or other objects
16. Do not use or store flammable gases or liquids such as hair gel, gasoline, paint, etc. near or inside the equipment to avoid accidents
Fire.
17. When using the room, two (dry) towels or bath towels should be placed one on top of the other and draped over the knees to absorb sweat.
18. Do not allow water from the body to enter the room without wiping it dry after being exposed to rain. After using the room for 6 hours, take a shower
19. Please do not eat within 1 hour before using the room to avoid discomfort
20. Before using the house, one should drink appropriate water
21. Warning: forbidden for the following patients: those with bleeding tendency, patients with severe hypertension, heart disease, tuberculosis, acute disease
Patients with high fever, malignant tumors, infectious skin diseases, pregnant women, and postpartum women.
22. Danger: It is prohibited to use with the following medical electronic products: cardiac pacing devices, implantable medical electronic machines, etc;